

OPERATING INSTRUCTIONS AND PARTS MANUAL

MODEL M-65

Clinchclip Nailer

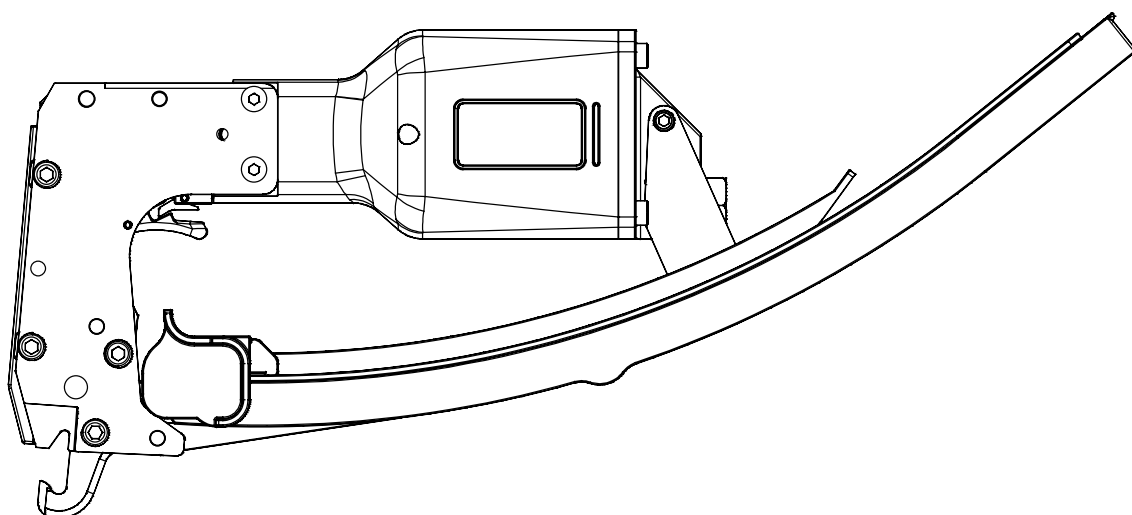

CAREFULLY READ THIS MANUAL BEFORE OPERATING TOOL

TOOL SPECIFICATIONS

MODEL OF TOOL	M-65
TOOL LENGTH	17.7" (450 mm)
TOOL HEIGHT	7.88" (200 mm)
TOOL WIDTH	3.74" (95 mm)
WEIGHT (WITHOUT FASTENERS)	6.6 lbs (3 kg)
AIR INLET	1/4" NPT

COMPRESSED AIR :

Maximum permissible operating pressure	115 PSIG (7.5 bar)
Recommended operating pressure range	75 - 110 psi (5 - 7 bar)
AIR CONSUMPTION.....	0.051 scfm with 25 nails per minute @ 90 psi (6.2 bar)

Noise dB(A) :

A-weighted sound pressure level LpA.....	83.94 dB(A)
A-weighted sound power level LwA.....	96.94 dB(A)
Measurement uncertainty: 3dB	
Vibration (m/s ²) :	
Hand-arm vibration value.....	4.82 m/s ²
Measurement uncertainty: 1.5 m/s ²	

Warning:

The vibration emission during actual use of the power tool can differ from the declared total value depending on the ways in which the tool is used; and of the need to identify safety measures to protect the operator that are based on an estimation of exposure in the actual conditions of use (taking account of all parts of the operation cycle such as the times when the tool is switched off and when it is running idle in addition to the trigger time).

List of fasteners for M-65 :

Crown	Width	Height	MAGAZINE
6.4 mm 0.25 "	19 - 22 mm 0.75 " - 0.86 "	12.7 - 15.5 mm 0.5 " - 0.6 "	50 pcs

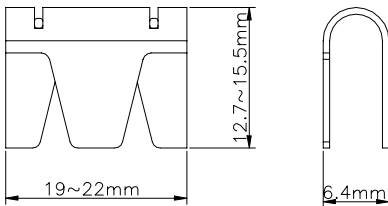

Foreword:

This tool has solid structure, strong force and diverse function to meet market demand. Its powerful clipping strength is able to tight two hard objects. Even with two different forms of wires can also be clinched. Square blade clip contributes a gate between two wires so the other wire can be rotated. User can achieve his desired purpose by using the tool.

Suitable applications:

Designed specifically for mattress, automotive seat cage, razor fence and upholstery.

Caution:

The tool is only for wire joining. It can not be used on soft material fastening would caused objects break.



DANGER

Indicates an imminently hazardous situation which, if not avoided, will result in death or serious injury.

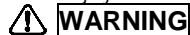

WARNING

Indicates an potentially hazardous situation which, if not avoided, will result in death or serious injury.



NOTE

Alerts the operator to useful information.

SAFETY INSTRUCTIONS



DANGER

1. Read this manual and understand all safety instructions before operation the tool. If you have any questions, please contact our authorized representatives.
2. Only those fasteners listed in the operating instructions may be used in the fastener driving tools.
3. Only the main energy and the lubricants listed in the operating instructions may be used.
4. Fastener driving tools equipped with contact actuation or continuous contact actuation, marked with the symbol " Do not use on scaffoldings, ladders", shall not be used for specific application for example:
when changing one driving location to another involves the use of scaffoldings, stairs, ladders, or ladder alike constructions, e.g. roof laths, closing boxes or crates,
fitting transportation safety systems e.g. on vehicles and wagons.
5. For the maintenance of fastener driving tools, only spare parts specified by the manufacturer or his authorized representative shall be used.
6. Repairs shall carried out by agents authorized by the manufacturer or by other specialis-

ts, having due regard to the information given in the operating instruction.

7. Stands for mounting the fastener driving tools to a support for example a work table shall be designed and constructed by the stand manufacturer in such a way that the fastener driving tool can be safely fixed for the intended use, thus for example avoiding damage, distortion or displacement.
8. Fastener driving tools operated by compressed air shall only be connected to compressed air lines where the maximum allowable pressure cannot be exceed by a factor of more than 10%, which can for example be achieved by a pressure reduction valve which includes a downstream safety valve.
9. When using fastener driving tools operated by compressed air, particular attention must be paid to avoid exceeding the maximum allowable pressure.
10. When using fastener driving tools operated by compressed air should only be operated at the lowest pressure required for the work process at hand, in order to prevent unnecessarily high noise levels, increased wear and resulting failures.
11. Hazards caused by fire and explosion when using oxygen or combustible gases for operating compressed air operated fastener driving tools.
12. Carry the fastener driving tool at workpiece using only the handgrip, and never with the trigger actuated. Never carry the tool by the hose or pull the hose to move the tool.

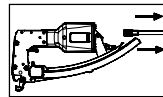

13. Disconnect the tool from air supply before cleaning jams, servicing, adjusting, and during non-operation.



14. Wear eye protection.

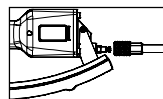

15. Do not use a check valve or any other fitting which allows air to remain in the tool.



16. Do not place your hand or any part of your body in the fastener discharge area of the tool when connecting or disconnecting air supply.



17. Never point tool at yourself or at any other person.

AIR SUPPLY AND CONNECTION



NOTE

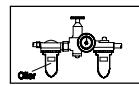

Many air tool users find it convenient to use oiler to help provide oil circulation through tool and increase the efficiency and useful life of the tool. Check oil level in the oiler daily.

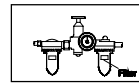

Many air tool user find it convenient to use a filter to remove liquid and impurities which can rust or wear internal parts of the tool. A filter also increase the efficiency and useful of the tool. The filter must be checked on a daily basis and if necessary drained. For better performance, install a 3/8" quick connector (1/4" NPT threads) with an inside diameter of .315" on your tool and a 3/8" quick coupler on the air hose.

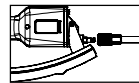

The following illustration shows the correct mode of connection to the air supply system which will increase the efficiency and useful life of the tool.

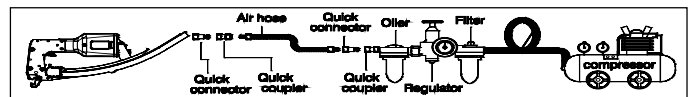

LUBRICATION AND MAINTENANCE



NOTE

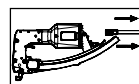

- Disconnect the air supply from the tool before lubricating.

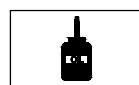

- Your tool requires lubrication before you use it for the first time.

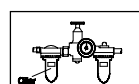

Wipe off excessive oil at the exhaust. Excessive oil will damage O-rings of tool. If in-line oiler is used, manual lubrication through the air inlet is not required on a daily basis.



Turn the tool so the inlet is facing up and put one drop of high speed spindle oil, UNOCAL RX22, or 3-IN-1 oil into air inlet. Never use detergent oil or additives. Operate the tool briefly after adding oil.

LOADING THE TOOL

⚠️ WARNING



Do not place your hand or any part of your body in the fastener discharge area of the tool when connecting or disconnecting air supply.

⚠️ WARNING



Never point any operational fastener driving tool at yourself or at any other person.

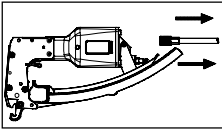

1. Disconnect air hose.

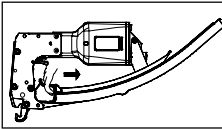

2. Depress the magazine latch. Pull back on the magazine cover.

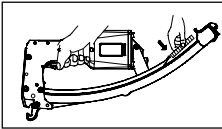

3. Insert a stick of fasteners into the magazine. Make sure the pointed ends of the fasteners are loaded with the points downward. Also make sure fasteners are not dirty or damaged.

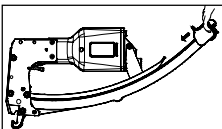

4. Push the magazine cover forward until the latch catches.

OPERATING THE TOOL

⚠️ WARNING



Protect your eyes and ears. Wear z87.1 safety glasses with side shields. Wear hearing protection. Employers and users are responsible for ensuring the user or anyone near the tool wear this safety protection.

⚠️ NOTE

Check and replace any damaged or worn components on the tool. The safety warning labels on the tool must also be replaced if they are not legible.

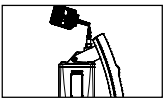

Fig.1

1. Add a few drops of UNOCAL RX22 or 3-in-1 oil into the air inlet. (See Fig. 1)

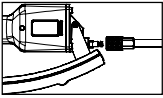

Fig.2

2. Attach a high flow quick connect fitting to the tool. (See Fig. 2)

3. Empty the magazine.

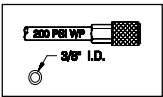

Fig.3

4. Connect the tool to an air compressor using a 3/8" I.D. hose. Make sure the hose has a rated working pressure exceeding 200 PSI (13.8bar) and a female quick coupler. (See Fig. 3)

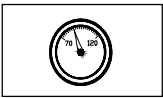

Fig.4

5. Regulate the air pressure to obtain 70 PSI (4.8 bar) at the tool. (See Fig. 4)

6. Disconnect the air supply from the tool.

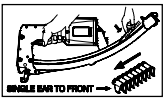

Fig.5

7. Load fasteners into your tool following the instructions in this manual. (See Fig. 5)

8. Reconnect the air supply to the tool.

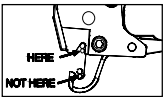
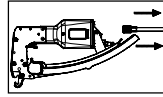

Fig.6

9. Place wires in notch of side plates by pushing tool down onto wires as shown in (See Fig. 6)

CLEARING A JAM FROM THE TOOL

⚠️ WARNING



Disconnect the tool from air compressor before adjusting, clearing jams, servicing, relocating and during non-operation.

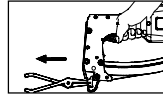

1. Fastener jammed in fastener discharge area:
Disconnect tool from air hose.
Grab jammed fastener with pliers and remove.

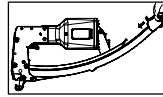

2. Fastener jam inside magazine:
Disconnect air tool from air hose.
Pull back on fastener pusher until locked.
Removed jammed fastener.
Release fastener pusher.

CLEANING THE TOOL

⚠️ DANGER

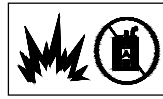

Never use gasoline or other flammable liquids to clean the tool. Vapors in the tool will ignite by a spark and cause the tool to explode and result in death or serious personal injury.

⚠️ NOTE

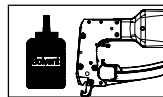

Solvents used to clean the nose of the tool and contact safety trip mechanism may soften the tar on the shingles and cause the buildup to be accelerated. Make sure to dry the tool thoroughly after cleaning and before operating the tool again.

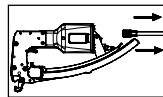

1. Disconnect the air supply from the tool.

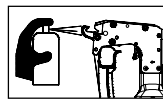

2. Remove tar buildup with kerosene #2 fuel oil or diesel fuel. Do not allow solvent to get into the cylinder or damage may occur. Dry off the tool completely before use.

TROUBLESHOOTING

Stop using the tool immediately if any of the following problems occur. Serious personal injury could. Any repairs or replacements must be done by a qualified person or an authorized service center only.

PROBLEM	CAUSE	SOLUTION
Blade does not return.	Sticky main valve.	Lubricate main valve; check that main valve piston moves.
Sluggish tool.	Dry main valve.	Lubricate main valve.
Clips not feeding.	Obstruction in magazine. Broken pusher spring.	Remove obstruction. Replace pusher spring.
Loose clips.	Low air pressure. Worn blade or anvil.	Increase pressure to 80 psi. Replace blade or anvil.
Clip jamming.	Clips are loaded backward into the magazine.	Check that single ear on clip is loaded forward into the magazine.
Tool not cycling.	Clogged trigger valve.	Clean trigger valve assembly.

M-65N01 (JT/65N-01)

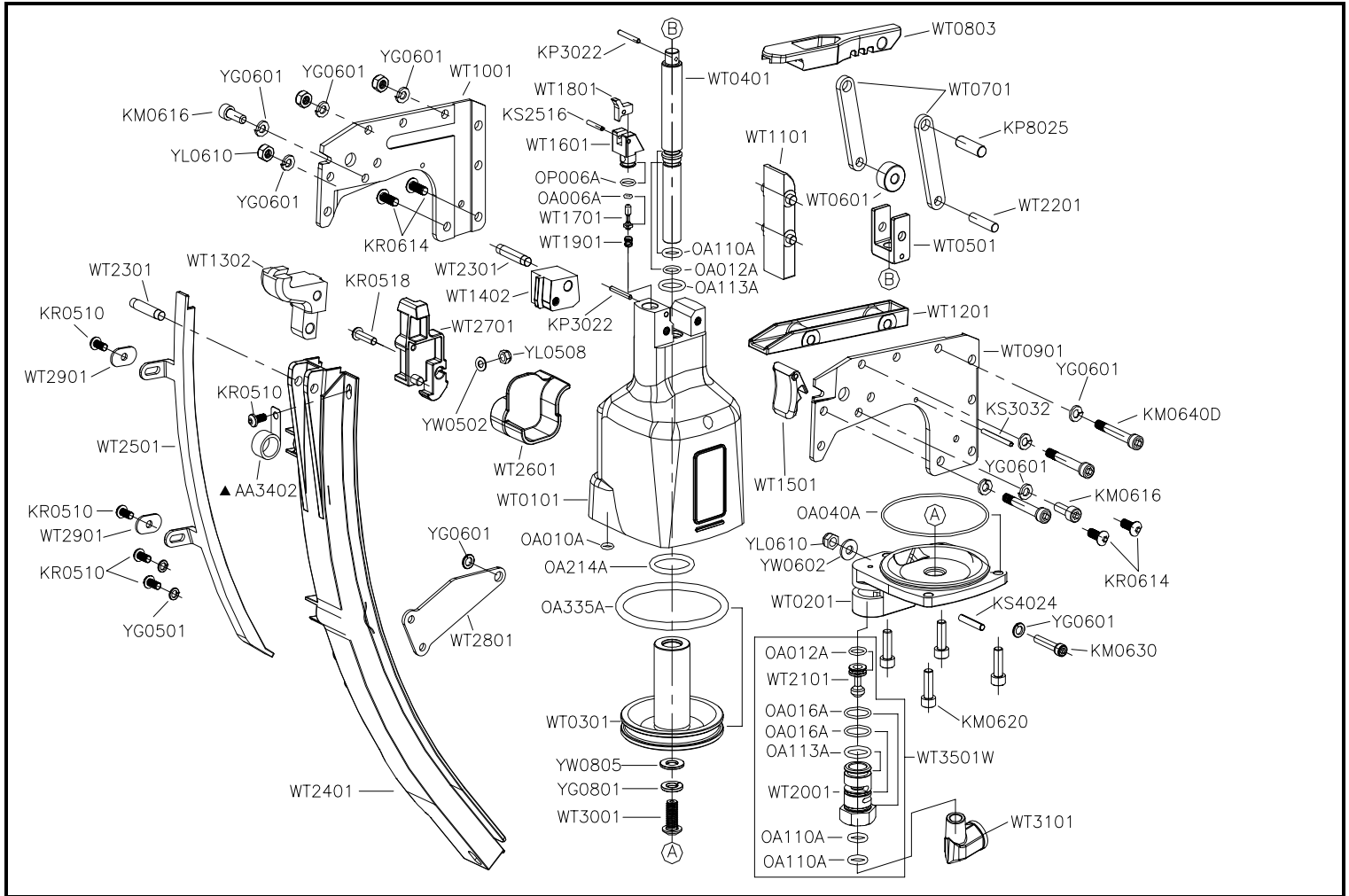

Part_No	Description	Spec	Q'ty	Part_No	Description	Spec	Q'ty	Part_No	Description	Spec	Q'ty
▲ AA3402	PUSHER SPRING		1	OP006A	O-RING	P6	1	WT2201	PIVOT		1
KM0616	HEX.SOC.HD.BOLT	M6×1.0 - 16L	2	WT0101	BODY		1	WT2301	PIVOT		2
KM0620	HEX.SOC.HD.BOLT	M6×1.0 - 20L	4	WT0201	END CAP		1	WT2401	NAIL SEAT		1
KM0630	HEX.SOC.HD.BOLT	M6×1.0 - 30L	1	WT0301	MAIN PISTON		1	WT2501	MAGAZINE COVER		1
KM0640D	HEX.SOC.HD.BOLT	M6×1.0 - 40L	3	WT0401	PISTON ROD		1	WT2601	PUSHER BRACKET		1
KP3022	PARALLEL PIN	3×22L	2	WT0501	YOKE-PISTON ROD		1	WT2701	PUSHER		1
KP8025	PARALLEL PIN	8×25L	1	WT0601	PIVOT		1	WT2801	SUPPORT		1
KR0510	BUTTON HD.BOLT	M5×0.8 - 10L	5	WT0701	LINK		2	WT2901	SPACER		2
KR0518	BUTTON HD.BOLT	M5×0.8 - 18L	1	WT0803	DRIVER BLADE		1	WT3001	BUTTON HD.BOLT		1
KR0614	BUTTON HD.BOLT	M6×1.0 - 14L	4	WT0901	SIDE PLATE(L.H.)		1	WT3101	ELBOW		1
KS2516	SPRING PIN	2.5-16L	1	WT1001	SIDE PLATE(R.H.)		1	WT3501W	MAIN VALVE ASSY.		1
KS3032	SPRING PIN	3-32L	1	WT1101	TOP PLATE CASTING-MACHINED		1	YG0501	SPRING WASHER	5	2
KS4024	SPRING PIN	4-24L	1	WT1201	FRONT PLATE		1	YG0601	SPRING WASHER	6	10
OA006A	O-RING	ARP568-006	1	WT1302	ANVIL		1	YG0801	SPRING WASHER	8	1
OA010A	O-RING	ARP568-010	1	WT1402	BLADE GUIDE		1	YL0508	LOCK NUT	M5×0.8	1
OA012A	O-RING	ARP568-012	2	WT1501	TRIGGER		1	YL0610	LOCK NUT	M6×1.0	4
OA016A	O-RING	ARP568-016	2	WT1601	PILOT VALVE BODY		1	YW0502	FLAT WASHER	5	1
OA040A	O-RING	ARP568-040	1	WT1701	VALVE STEM		1	YW0602	FLAT WASHER	6	1
OA110A	O-RING	ARP568-110	3	WT1801	VALVE LEVER		1	YW0805	FLAT WASHER	8	1
OA113A	O-RING	ARP568-113	2	WT1901	COMPRESSION SPRING		1				
OA214A	O-RING	ARP568-214	1	WT2001	MAIN VALVE BODY		1				
OA335A	O-RING	ARP568-335	1	WT2101	VALVE PISTON		1				

If you need to order parts, please mark both Parts No. and Description.